

Operating Instructions

Thank you very much for choosing SLIK Pan head.

SLIK Corporation has designed your pan head to be a sturdy, rugged, dependable product that will provide you with many years of satisfactory use.

Please take a few moments to read this operating instruction carefully before use so that you can take full advantage of your Pan head's many fine features.

Retain this operating instruction in case you might want to refer back to it.

⚠ Caution

This caution icon refers to information pertaining to important safety procedures in preventing injuries, or damages which may occur as a result of mishandling this product.

🚫 Prohibition

This prohibited icon refers to information pertaining to prohibited contents. Please refer to instructions closely to avoid accidents.

Specification

SH-726E

Height	104mm (4 1/8")
Weight	0.58kg (1lbs 5oz)
Camera mounting screw	U1/4
Tripod mounting screw	U1/4

M321

Components

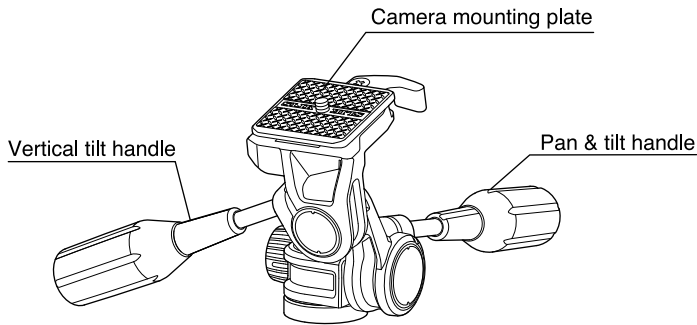

Camera mounting screw

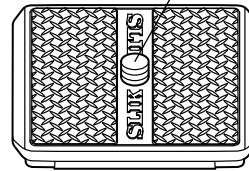

Mounting wing nut

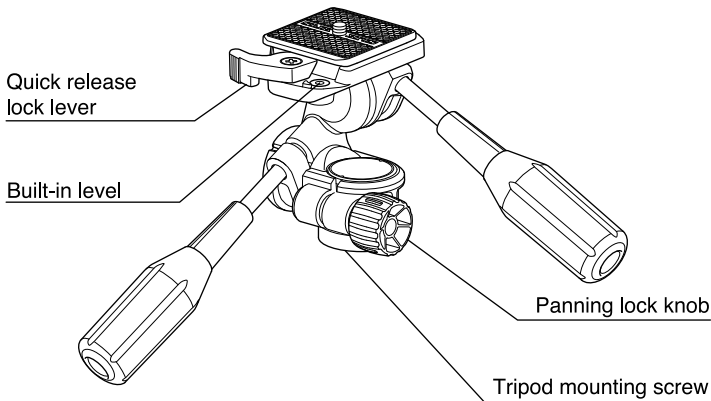
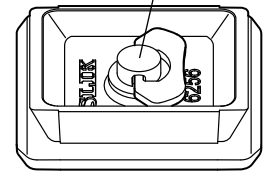

Carrying the tripod

🚫 Prohibition

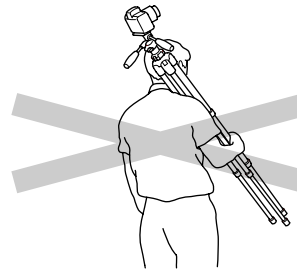

Carrying a tripod with a camera left on can result in unexpected accidents. We therefore, recommend you to remove your camera while carrying the tripod.

Equipment that can be loaded on this pan head

🚫 Prohibition

⚠ Caution

This product has been designed to handle equipment weighing under 5 kgs (11 lbs). Do not overload. Some equipments weighing under 5 kgs (11 lbs), such as long lenses, may not balance well due to its weight distribution. In such case, please use a larger Panhead.

Install the panhandle

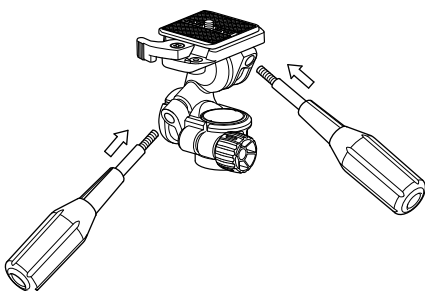

Panhandle are installed as shown. There is not difference in length between the panhandle, and screw into the back of the pan & tilt handle. Panhandle is installed in both side.

Storage

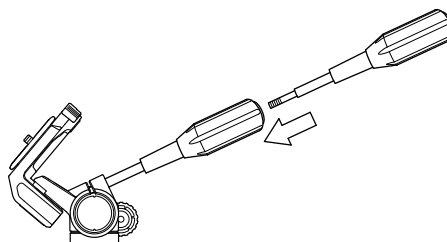

Remove the vertical tilt handle from the panhead, and screw into the back of the pan & tilt handle.

Built-in level

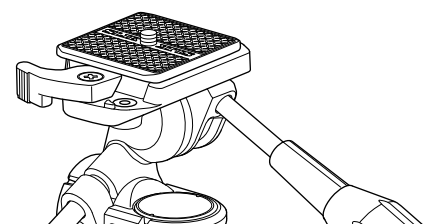

Adjust the built-in level to fit into the middle.

Attaching the camera to the quick release platform

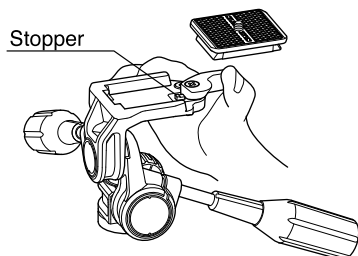

Remove the quick release platform turning the lock lever. In this case, please do not put the lock lever back by force as it has been stood by the stopper.

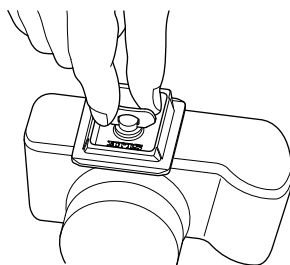

Align the length of the platform along the base of the camera body, and securely tighten the mounting wing nut.

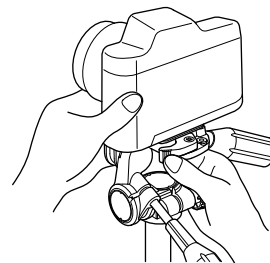

When you fix this quick release platform to pan head, the quick release lock lever will return to the original position automatically. We, however, recommend you to tighten this lever more to secure the fixing.

Using the pan head

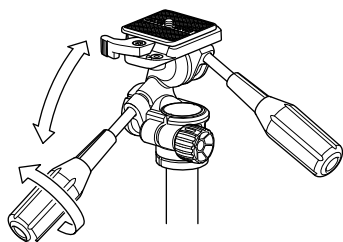

Loosen the pan & tilt handle, and the head will tilt back and forth.

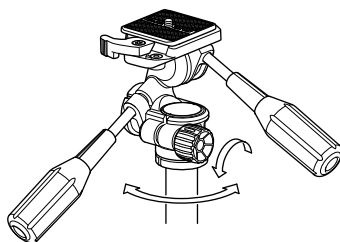

Loosen the panning lock knob, and the head will rotate along the horizontal direction.

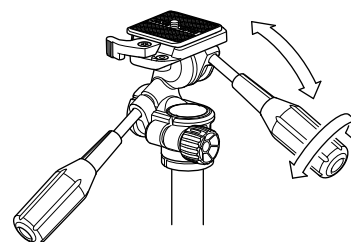

Loosen the vertical tilt handle, and the level can be adjusted.

Removing the pan head from the center column

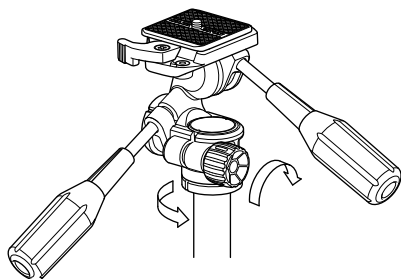

Use the following instructions if you wish to change to another heads, or attach accessories. First, lock the panning lock knob, then grasp the pan, or vertical tilt handle and turn the head, counter-clockwise to loosen.

Setting the pan head from the center column

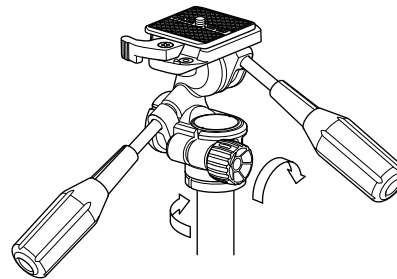

Set the new head, or accessory on the tripod's threaded post, and turn clockwise until it comes to a stop. Tighten the panning lock knob and turn clockwise slightly more.

Care of the Tripod

- DO NOT apply any grease or oil to this product.
- Clean with a mild detergent and a soft cloth only.
- DO NOT use close to flame. Avoid extreme heat.



Slik Corporation reserves the right to make changes in design and/or improvements on the products without any obligation and advanced notice.

SLIK CORPORATION

853 Kayama, Hidaka City, Saitama 350-1231 Japan Phone 81-42-989-2141, Fax. 81-42-985-0210 ©2010

Printed in Thailand.