

### Operating Instructions

Thank you very much for choosing SLIK SPRINT PRO II 3 WAY Tripod. The SLIK Corporation has designed your tripod to be a sturdy, rugged and dependable product that will provide you with many years of satisfactory use.

Please take a few moments to read these operating instructions carefully before use so that you can take full advantage of your Tripod's many fine features. Retain this operating instruction sheet in case you might want to refer back to it.

#### ⚠ Caution

This caution icon refers to information pertaining to important safety procedures in preventing injuries, or damages which may occur as a result of mishandling this product.

#### 🚫 Prohibition

This prohibited icon refers to information pertaining to prohibited contents. Please refer to instructions closely to avoid accidents.

K537

### Components

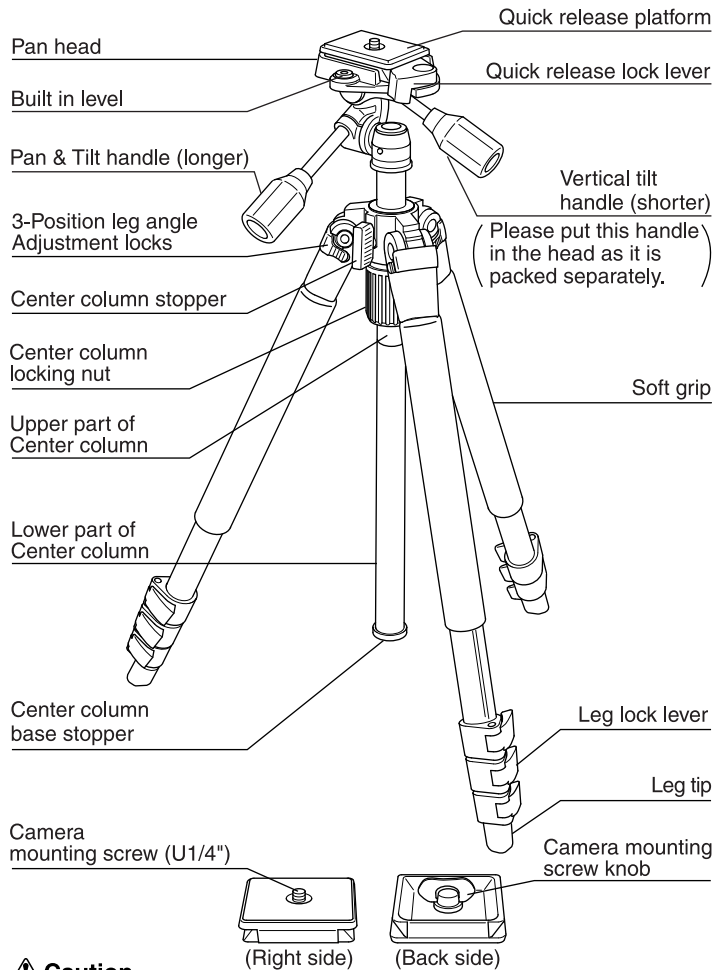

#### ⚠ Caution

Soft Grip is consumption and cannot be used permanently. Please replace it whenever it is ragged.

### Equipment that can be loaded on this Tripod

This product has been designed to handle equipment weighing under 2 kgs (4 lbs 6 oz). Do not overload.

Some equipments weighing under 2 kgs (4 lbs 6 oz), such as long lenses, may not balance well due to its weight distribution. In such case use a larger tripod.

### Carrying the Tripod

#### 🚫 Prohibition

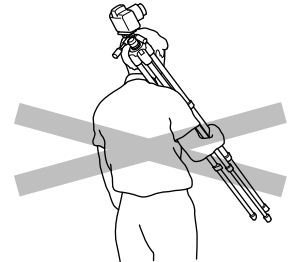

Carrying a tripod with a camera left on can result in unexpected accidents.

We therefore, recommend you to remove your camera while carrying the tripod.

### Setting up

#### ⚠ Caution

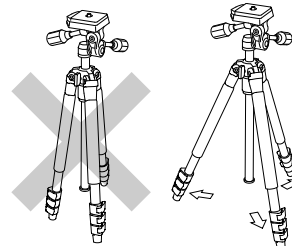

To prevent accidental equipment fall or tripod tipping over making sure all levers, knobs and handles on the tripod are securely tightened, and that all three legs are opened all the way.

### Attaching the camera to the Quick release platform

#### ⚠ Caution

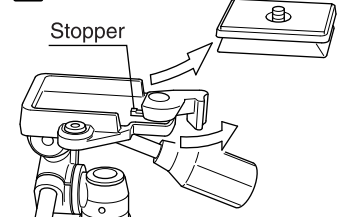

To remove the Quick release plate, turn the Quick release plate locking lever. In this case do not put the lock lever back by force as it has been stood by the stopper.

### Using the Pan Head

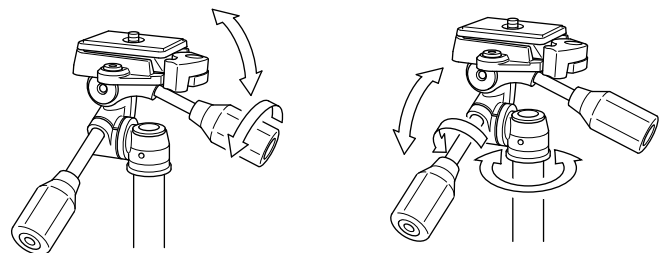

When you unlock the Vertical tilt handle, your camera is free to move up and down.

When the pan & tilt handle are unlocked, you can pan & tilt simultaneously.

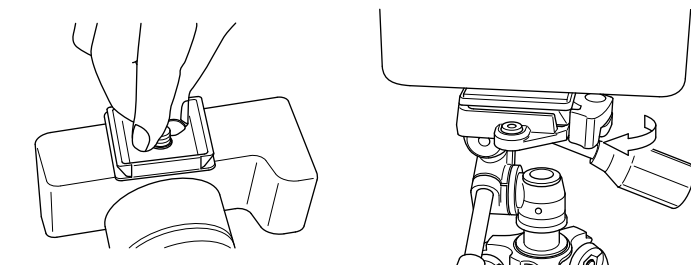

Insert the Camera mounting screw on the Quick release plate in the place of the tripod attachment screw of your camera. Turn the Camera mounting screw knob and fix firmly.

To attach the plate, slide into Quick release plate slantways. It will be closed automatically after attaching. Fasten the plate Locking Lever tightly. It must be certainly fixed.

## How to use the Center column

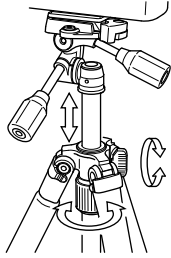

Loosen the Center column stopper while you are holding the Pan head. Then loosen the Center column locking nut. After the fixing of your desired height, tighten the both of the Center column stopper and the Center column locking nut firmly before you keep your hands away from the Pan Head.

## Three position adjustable legs

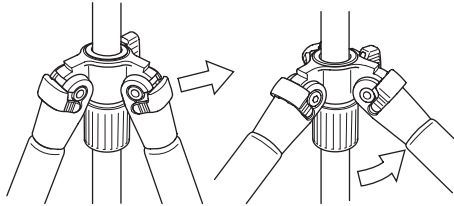

To change the angle of each leg, close the leg slightly. Then pull the 3-position leg angle adjustment locks. There is a choice of two other angle positions.

## ⚠ Caution

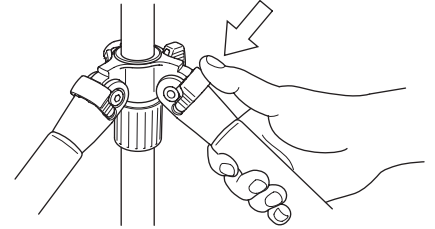

After choosing the desired leg angle, securely push the Adjustment lock.

## How to get low position shots

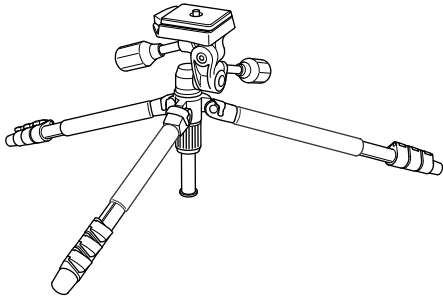

You can get lower height as show the above.

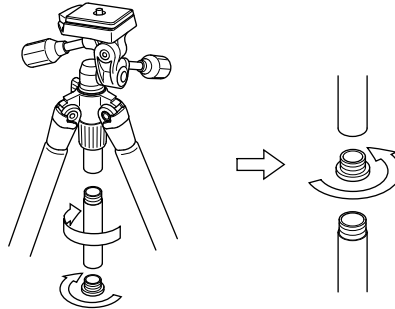

Remove the Center column base stopper. Then remove the Lower part of Center column. Put the Center column base stopper in to the Upper part of Center column.

## Extending/Folding of Tripod legs

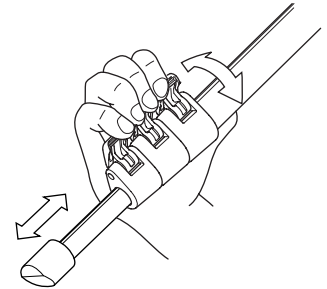

Flip up the Leg lock lever to extend or shorten any of the individual leg sections to the desired length. Press the leg lock lever flush against the leg to lock.

## Invertible Center column

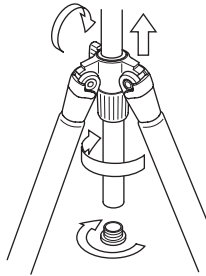

It can be used for digital copy/or close-up photography when a Center column is inserted from the bottom. Remove a Center column base stopper. Then loosen a Center column stopper and Center column locking nut.

## ⚠ Caution

Center column base stopper should be attached.

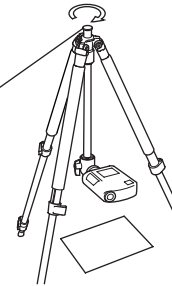

Insert a Center column from the bottom. Tighten a Center column stopper and Center column locking nut firmly. Please also make sure to attach a Center column base stopper for fall prevention.

## Care of the Tripod

- DO NOT apply any grease or oil to this product.
- Clean with a mild detergent and a soft cloth only.
- DO NOT use close to flame. Avoid extreme heat.



Slik Corporation reserves the right to make changes in design and/or improvements on the products without any obligation and advanced notice.

SLIK CORPORATION

853 Kayama, Hidaka City, Saitama 350-1231, Japan Phone 81-42-989-2141, Fax. 81-42-985-0210 ©2008

Printed in Thailand